

## Placement of Saf-T Locking Brackets™ and Rear Support Braces™

### Legend:

X = Saf-T Locking Brackets™

▬ = Rear Support Brace™

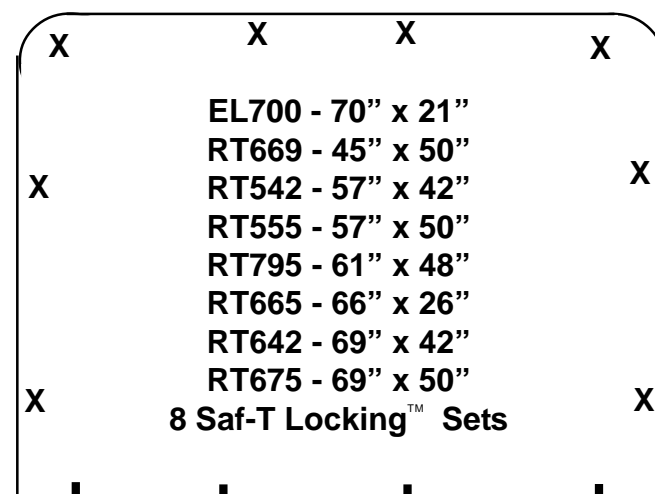
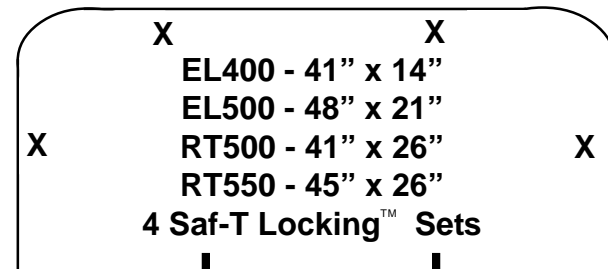
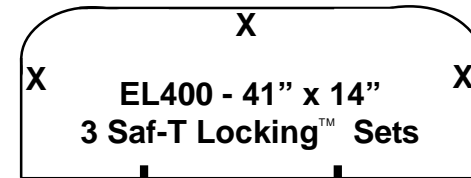
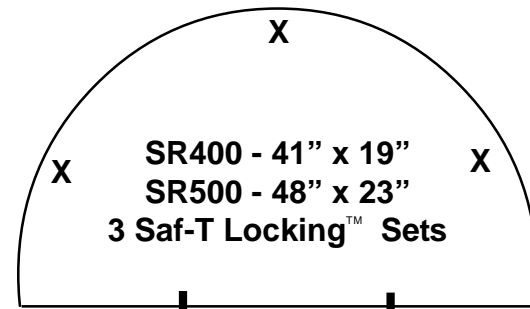

### Center, Aluminum Support Chart

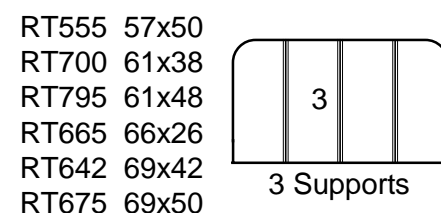
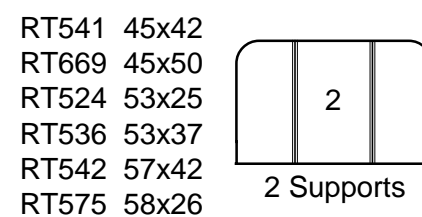
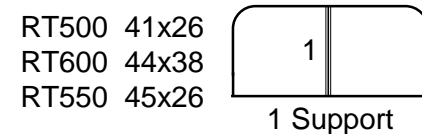
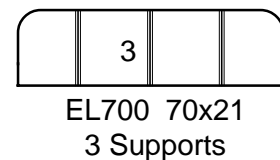
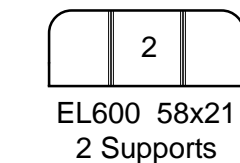
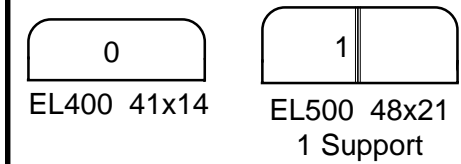
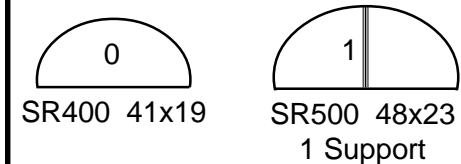

The Ultra Protect window well cover™ has been designed to be aesthetically pleasing and constructed with materials to last many years. Closely follow this installation guide to insure that your Ultra Protect window well cover™ is properly installed. Because building codes vary, check with your village or town to insure that our Ultra Protect Window well Covers™ do not infringe upon their regulations.

**Recommended Tools:** Drill, 5/16" Drill Bit, 5/32" Masonry Drill Bit, Adjustable Wrench, Jig Saw (optional) Hack Saw (optional)

**1.** Place your window well cover over the window well (smooth side up). When properly installed, the rear aluminum frame should rest on top of the window well against the house. The window well cover should extend **at least 3/4"** past the entire perimeter of the window well. If you have a metal window well and it appears to be bent or out of shape, remove the well cover and gently tap the well with a sledge hammer to conform the well to it's proper, original shape.

**2.** Center your window well cover on the window well. We recommend that the cover overhangs **at least 3/4"** over the window well. If the window well cover is much larger than the window well itself, you may, if desired, trim the cover using an ordinary jig saw with a fine tooth blade. If trimming, center the well cover on the window well, using a marker or crayon, draw an outline **at least 3/4"** around the outside perimeter of the window well. Remove the well cover and very carefully trim the excess material. Be careful not trim through any rivets while cutting through aluminum pieces.

**3.** Note - Because window wells vary thickness, or If your window well is concrete or thick plastic, you may require additional mounting hardware other than what is provided (i.e.. longer bolts). See a store associate for assistance in choosing the most appropriate hardware. Using the diagrams on the left side of this page as a guide (find your model number), you will now mark (with a pencil or marker) the positions where the 4" brackets will be installed. **It is important that you correctly mark these positions. If your window well cover has aluminum center supports, your brackets will be installed a 1/4" higher than the top of your window well (see Fig. 2). If your window well does not have aluminum center supports (Models: SR400 & EL400), the top of the bracket will be level with the top of your window well (see Fig. 1).** Position each bracket on the inside of your window well and using a pencil or marker, mark the position where you will need to drill a 5/16" hole through your window well (shown in Fig 1., step A). Repeat for each bracket. Once you have marked all of the hole positions, drill a hole on each mark on using a 5/16" drill bit. Using one u-bolt, check each set of holes to ensure they where properly drilled.

### 4. MOUNTING THE BRACKETS

You have two choices in mounting the brackets - Depending upon the thickness of your window well, you may choose the "Standard Installation" where you may have to saw cut the ends of the U-bolts, or, you may choose the "Quick Installation Method".

**Standard Installation:** As shown in Figure 1, secure the brackets, using the U-bolts and flange nuts supplied.

If the remaining U-bolt thread extends to far into the bracket, it will be necessary to cut (using a hack saw) each U-bolt so that the threads are flush with the end of the nuts.

**Tip -** After tightening the nuts with an adjustable wrench or socket, you can grab the threads of the U-bolts bolts with pliers (*larger pliers work easier*) and twist back and forth. This action will shear the bolt even with the nut.

**Quick Installation Method:** As shown in Figure 3, Secure each bracket using the U-bolts, tightening each nut on the outside of the window well. Depending upon how much U-bolt thread is exposed after installation, using a hack saw you may choose to trim off the excess material so that the threads are flush with the outside of the nut.

**5.** With the brackets installed, center the well cover over the window well. Use a marker or crayon and place a mark on the window well cover over the hole in the mounted bracket (see Step B - Fig. 1 - All models). Using a 5/16" drill bit, carefully drill the marked hole through the window well cover. As shown if Figures 1 and 2, insert a clevis pin through the window well cover and through the bracket. Secure the bottom of the clevis pin by inserting a Quick Release Pull Pin (Fig. 4) in the open hole under the bracket. Repeat this step for the remaining brackets.

**Following the directions in figure 5, install the rear braces (ALL MODELS).**

**Figure 1** Models which use this diagram:  
SR400 and EL400

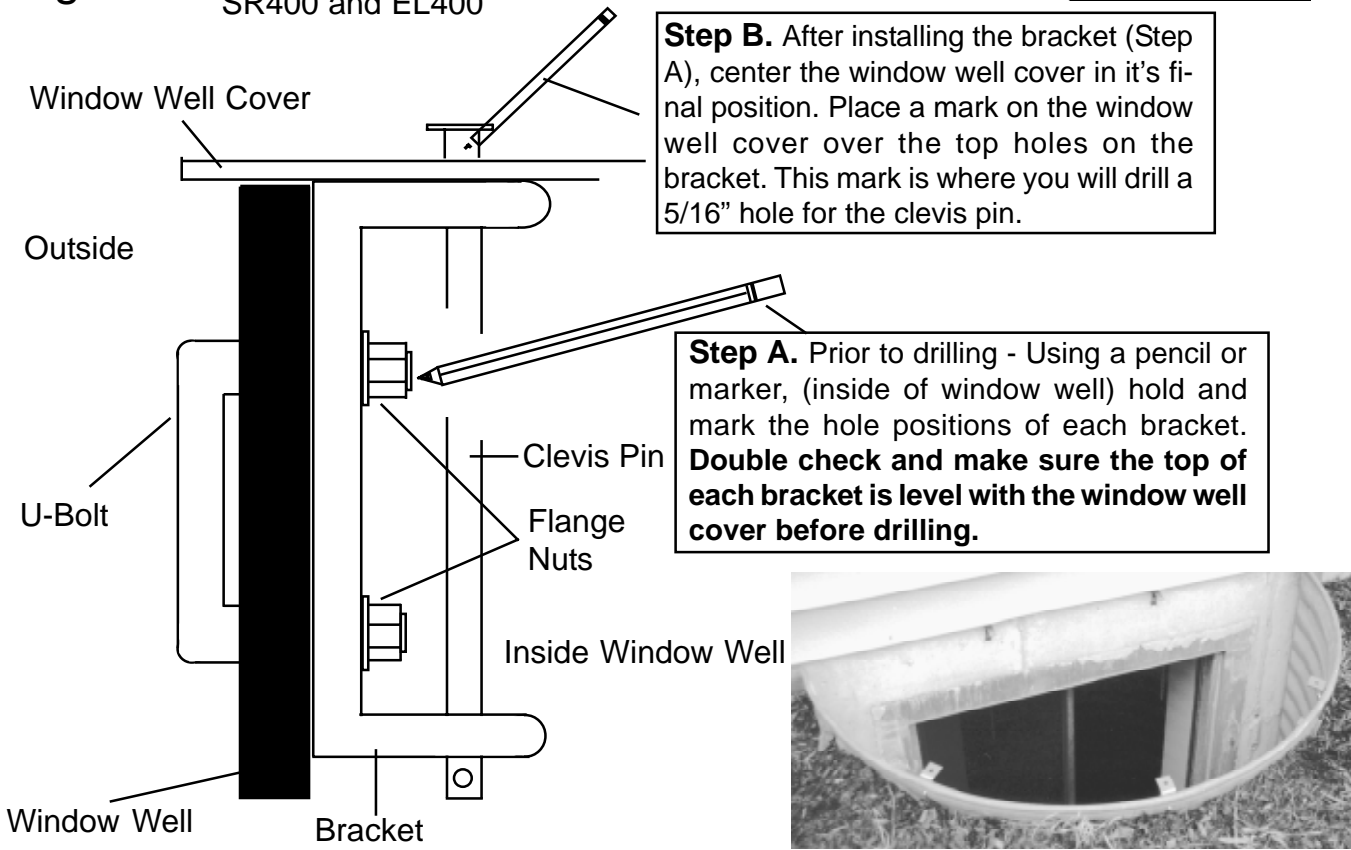

**Figure 2**

Models which use this diagram:  
SR500  
EL500, EL600, EL700, RT524, RT536,  
RT500, RT541, RT542, RT550, RT555,  
RT575, RT600, RT642, RT665, RT669,  
RT675, RT700, RT795

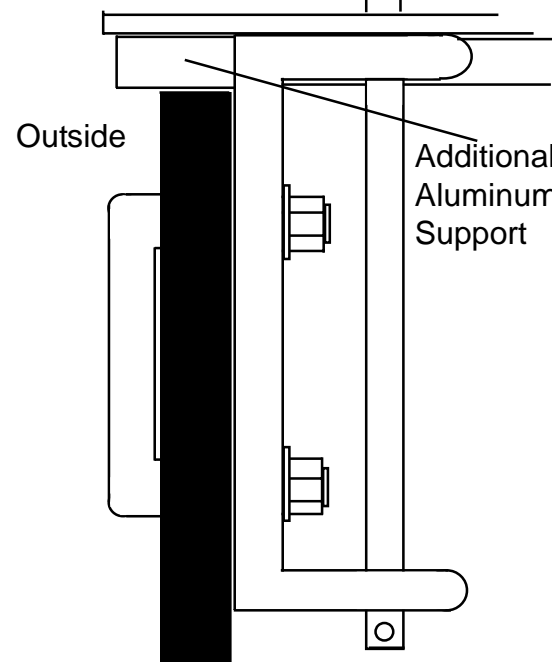

**Figure 3**  
**QUICK INSTALLATION METHOD**  
**DOES NOT REQUIRE YOU TO CUT U-BOLTS**

Models which use this diagram:  
SR400 and EL400

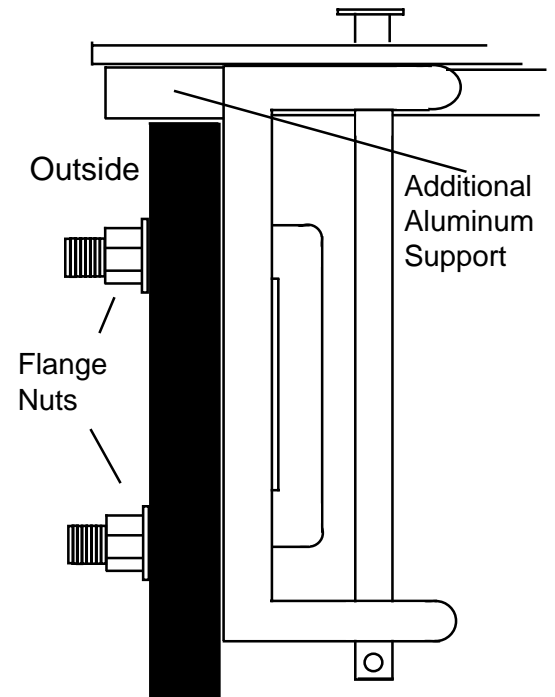
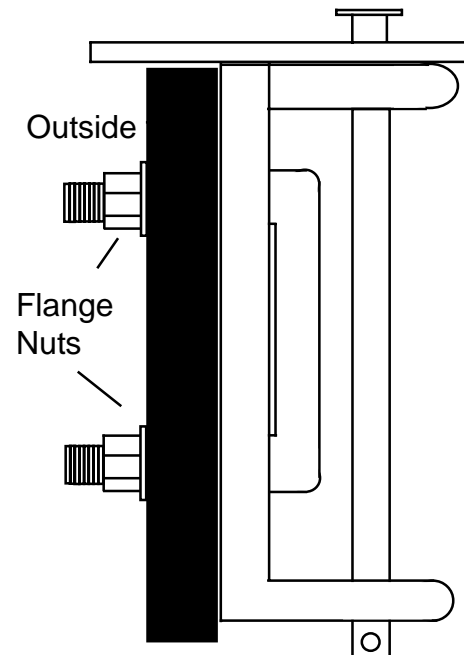

Models which use this diagram:  
SR500  
EL500, EL600, EL700, RT524, RT536,  
RT500, RT541, RT542, RT550, RT555,  
RT575, RT600, RT642, RT665, RT669,  
RT675, RT700, RT795

Concrete / Brick window wells - Supplement U-Bolts with appropriate masonry fastener to secure bracket to window well.

Wood / Timber window wells - Supplement U-Bolts with appropriate "lag" type screw to secure to wood window well.

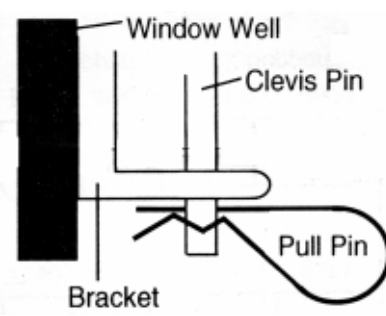

**Figure 4**

The Quick Release Pull Pins **MUST** be installed as pictured.

**Figure 5**

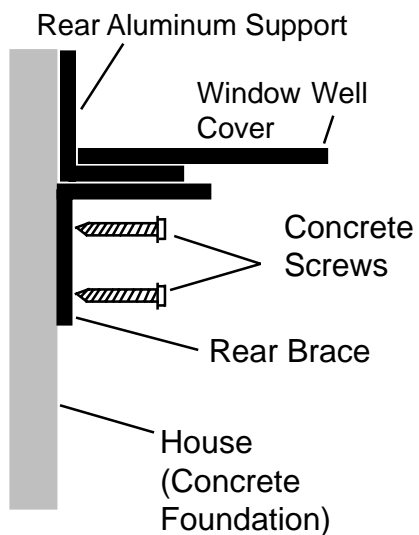

**Rear Braces Must Be Installed**

Your window well cover has been supplied with a rear brace set (rear braces and blue concrete screws). Depending upon your installation, it may be easier to perform this step working from inside your window well. Spaced evenly, mark the hole positions of each rear brace which will be installed to your home, directly under the main, aluminum support. Once you have marked these positions on the house foundation, drill (using a 5/32" masonry drill bit) all of the holes. Attach and tighten the rear braces as shown in the diagram on the left.

**Practice removing the pull pins and insure that everyone living in the home is familiar with the removal of the window well cover and its operation.**  
**WARNING - DO NOT INSTALL OR USE ANY TYPE OF LOCK OR DEVISE OTHER THAN THE QUICK RELEASE PULL PINS!**

**Recommended Maintenance** - To ensure safe operation and quick release of your window well cover, you should remove and clean the window well cover, about every 6 months. You should wipe down the entire window well cover, clevis pins, Quick Release Pull Pins and the brackets. Never use solvents or harsh chemicals when cleaning any part of the window well cover.

**LIFETIME WARRANTY**

Dyne, Inc.® warrants that its Ultra Protect window well covers™ will be warranted for life from the date of purchase. This warranty only extends to the original consumer purchaser and is not transferrable. This warranty does not apply to damage from accident, vandalism, natural acts of God, fire, misuse, alteration, improper assembly, improper installation, improper maintenance or abuse. In the event this window well cover becomes defective, the manufacturer will, at its option, arrange for replacement or repair of the window well cover within 45 days of receipt of written notice of such defect together with proof of purchase in the way of an original store receipt. Dyne, Inc.® will repair or replace a defective window well cover free of charge (except for dealer labor and shipping). Contact Dyne, Inc.® at the Internet address below or see your Ultra Protect™ dealer to obtain service under this warranty. Repair or replacement shall be the sole remedy of the purchaser under this warranty, and in no event shall Dyne, Inc. be liable for any incidental or consequential damages, losses or expenses. Some states do not allow the exclusion or limitation of incidental or consequential damages, so the above limitation or exclusion may not apply to you. This warranty gives you specific legal rights, and you may also have other rights which vary from state to state.